

☆☆☆129 Series☆☆☆

RoHS Compliant

P/N: H129S\*\*000

Available: 2~15pins

Insulator: Nylon 6/6 UL 94V-0

REVISIONS					
REV	ECN	DESCRIPTION	DATE	DRAWN	APPROVED
B					
C					

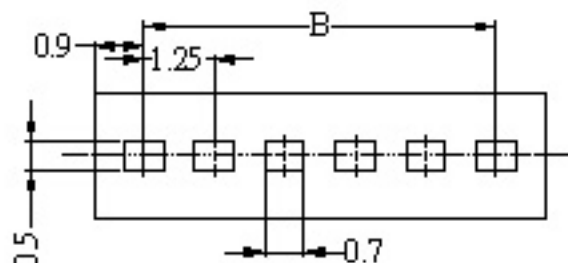
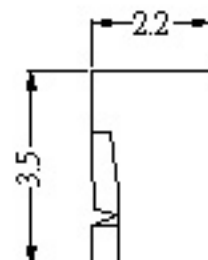
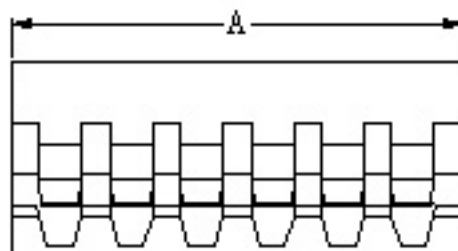
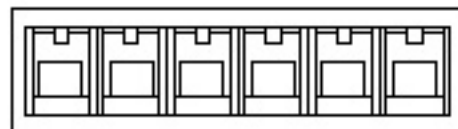

CIRCUITS	PART NO.	Dim A	Dim B
2	H129S02000	3.05	1.25
3	H129S03000	4.30	2.50
4	H129S04000	5.55	3.75
5	H129S05000	6.80	5.00
6	H129S06000	8.05	6.25
7	H129S07000	9.30	7.50
8	H129S08000	10.55	8.75
9	H129S09000	11.80	10.00
10	H129S10000	13.05	11.25
11	H129S11000	14.30	12.50
12	H129S12000	15.55	13.75
13	H129S13000	16.80	15.00
14	H129S14000	18.05	16.25
15	H129S15000	19.30	17.50

 **TCO** 上廣電子(惠州)有限公司  
Top conn electrical (HuiZhou) co.,ltd

NORMAL DIMENSION TOLBRANCE

X ±0.30 X' ±2'  
XX ±0.20  
XXX ±0.10

SIZE A4 REV A

UNITS

mm

SCALE

1:1

MATERIAL

TREATMENT

QUANTITY

THIRD ANGLE

PROJECTION



SHHT

LOP 1

TITLE

Housing

DWG NO

H129S\*\*000

DRAWN

Proc 2008.06.30

CHECKED

APPROVED

☆☆☆129 Series ☆☆☆

P/N: T129P00 T00

Conductor: Phosphor Bronze/Tin Plated

Thickness: 0.15mm

Applicable Wire: 28~32AWG

RoHS Compliant

REVISIONS

REV	ECN	DESCRIPTION	DATE	DRAWN	APPROVED
B					
C					

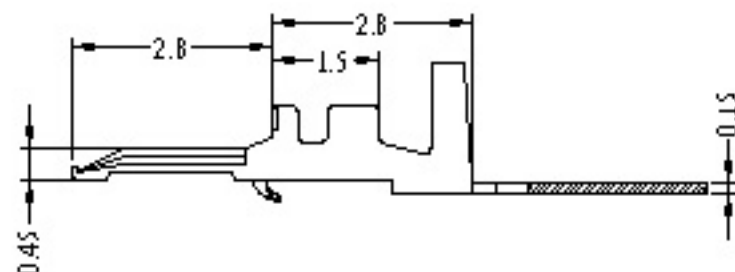
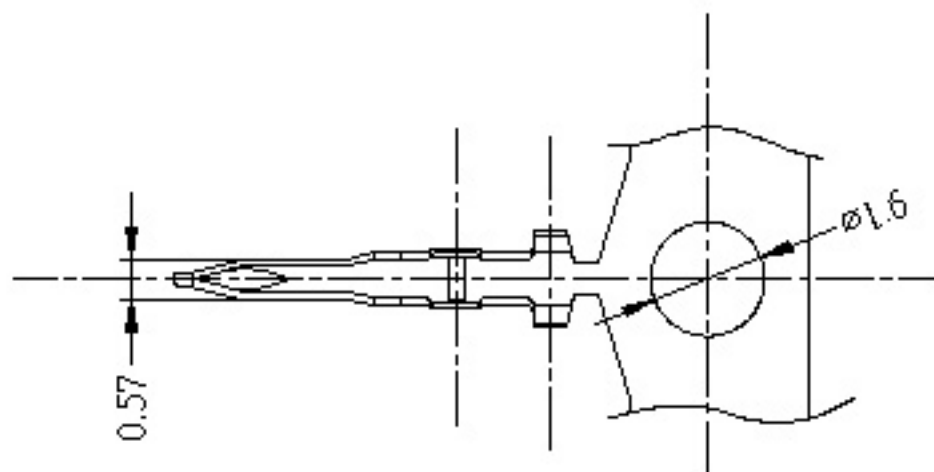
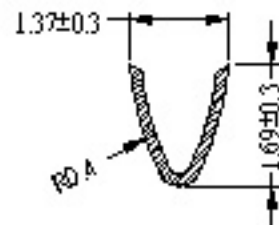
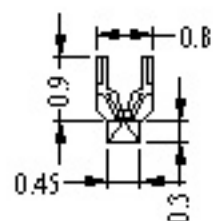
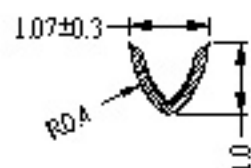

**TCO** 上廣電子(惠州)有限公司  
Top conn electrical (HuiZhou) co.,ltd

NORMAL DIMENSION TOLERANCE

X ±0.30 X' ±0.25  
XX ±0.20  
XXX ±0.10

SIZE A4 REV A

UNITS

mm

SCALE

1:1

MATERIAL

TREATMENT

QUANTITY

THIRD ANGLE

PROJECTION

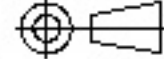

SHHT 1 OF 1

TITLE

DWG NO

DRAWN

CHECKED

APPROVED

Terminal

T129P00 T00

DATE 2008.06.30