

☆☆☆ 保險盒 ☆☆☆

RoHS Compliant

Insulator: Nylon 94V-0

Color: Black

REVISIONS

REV	RCN	DESCRIPTION	DATE	DRAWN	APPROVED
B					
C					

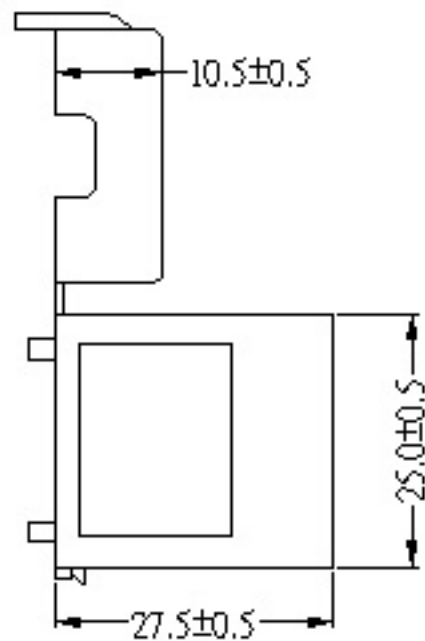
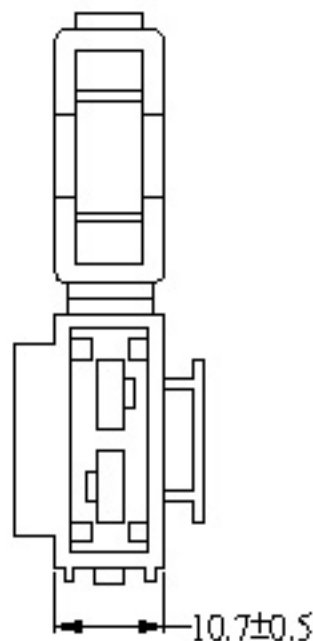
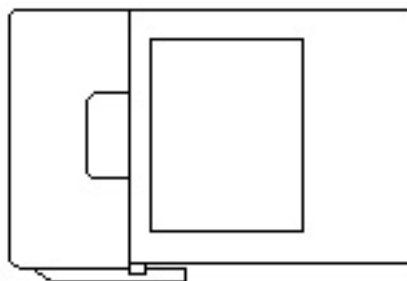

**TCO** 上廣電子(惠州)有限公司  
Top conn electrical (HuiZhou) co.,ltd

NORMAL DIMENSION TOLERANCE  
X ±0.30 X. ㎉  
.XX ±0.20  
.XXX ±0.10

SIZE	A4	REV	A
------	----	-----	---

UNITS	mm
SCALE	1:1
MATERIAL	
HEATMENT	
QUANTITY	

THIRD ANGLE PROJECTION

SHEET 1 OF 1

TITLE	Housing
DWG NO.	H250-02PB-10A
DRAWN	Xie 2007.12.22
CHECKED	
APPROVED	

☆☆☆H250 Series☆☆☆

RoHS Compliant

P/N: H250S01000

Insulator: Nylon 6/6 UL 94V-2

Color: Black

REVISIONS					
REV	ECN	DESCRIPTION	DATE	DRAWN	APPROVED
B					
C					

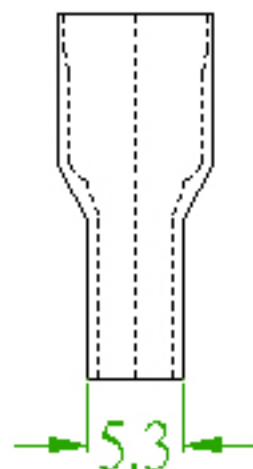
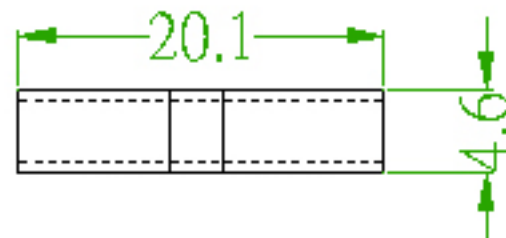

**TCO** 上廣電子(惠州)有限公司  
Top com electrical (HuiZhou) co.,ltd

NORMAL DIMENSION TOLERANCE

X ±0.30 X. ±2°  
XX ±0.20  
XXX ±0.10

SIZE A4 REV A

UNITS mm

SCALE 1:1

MATERIAL

TREATMENT

QUANTITY

THIRD ANGLE PROJECTION



SHEET 1 OF 1

TITLE Housing

DWG NO. H250S01000

DRAWN Hc 20004.28

CHECKED

APPROVED

A

B

C

D

E

F

☆☆☆ 250 Series ☆☆☆

P/N: T250B00TM0-Extended

Conductor: Phosphor Bronze, More than 40u" Tin-Plated

Thickness: 0.8mm

REVISIONS			
REV	DESCRIPTION	DATE	DRAWN
A			

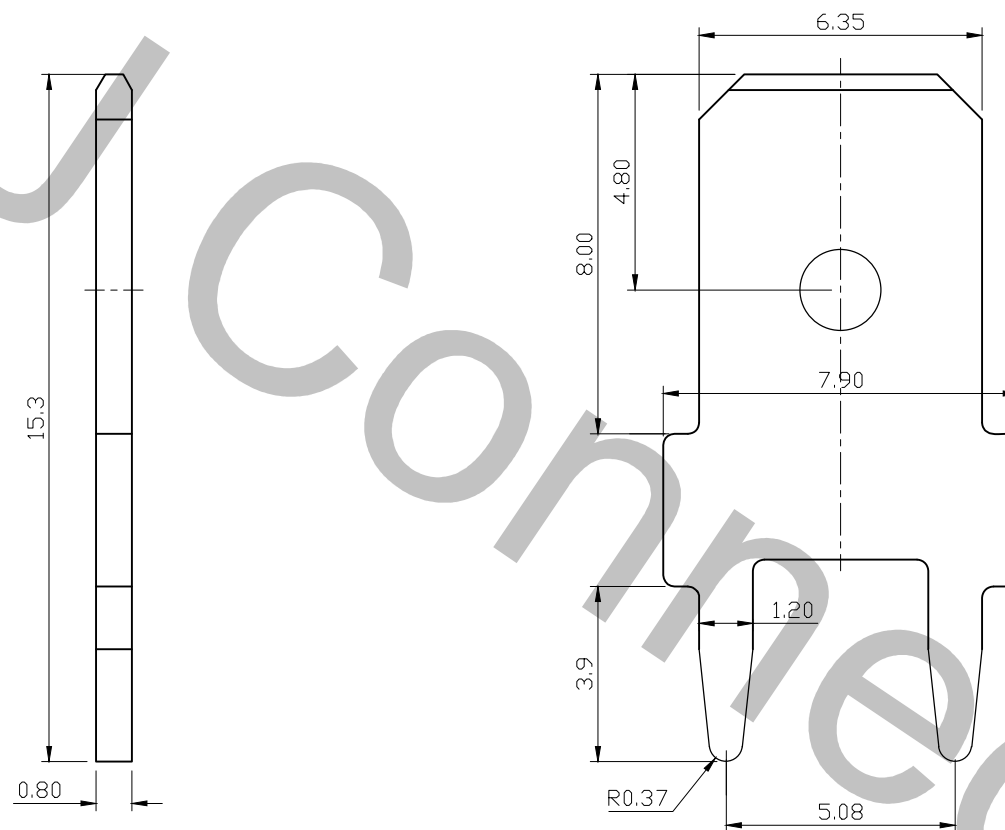

RoHS Compliant



C&amp;J Connector

TEL: 886-2-86871898 FAX: 886-2-86872959  
 Mail: tceldh@gmail.com Web: http://www.cnj.tw/

TITLE

250 Series Fast-On Male Tab

DIMENSION TOLERANCE

.x ±0.30 x° ±2°

.xx ±0.20

.xxx ±0.10

P/N	T250B00TM0-Extended	CHECKED	David	UNIT	mm	DATE	2010/08/31
DRAWN	Michael	APPROVED	Lily	SCALE	1:1	REV	A

A

B

C

D

E

F

☆☆☆187 Series ☆☆☆

RoHS Compliant

REVISIONS

REV	ECN	DESCRIPTION	DATE	DRAWN	APPROVED
B					
C					

P/N: T250B00TM0-加长

Conductor: Phosphor Bronze/More than 40u" Tin Plated

Thickness: 0.8mm

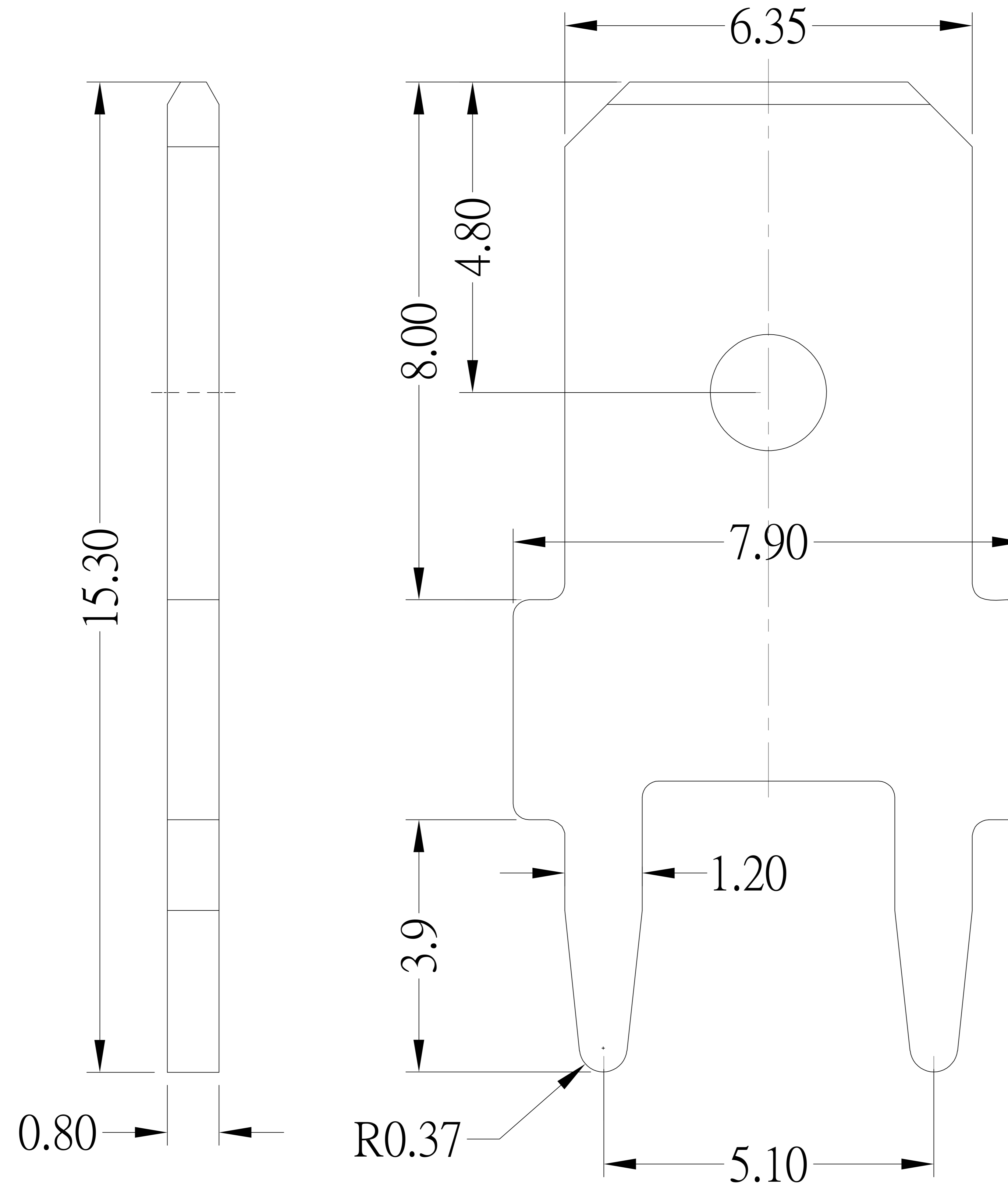

☆☆☆250 Series ☆☆☆

RoHS Compliant

REVISIONS					
REV	ECN	DESCRIPTION	DATE	DRAWN	APPROVED
B					
C					

P/N: T250PF0TGF

Conductor: Phosphor Bronze/Tin Plated 80~120u" over Ni 20u"

Thickness: 0.4mm

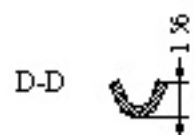
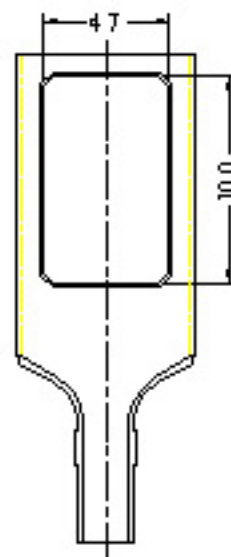
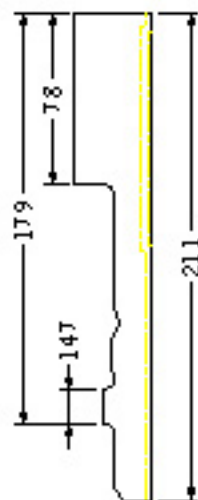
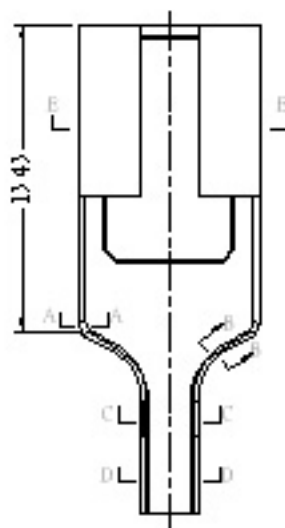
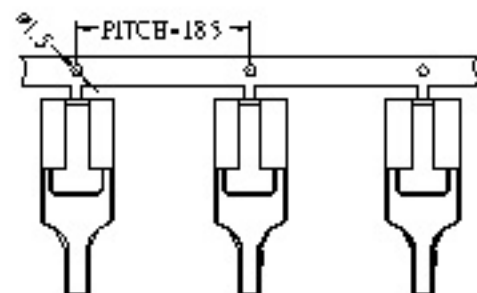
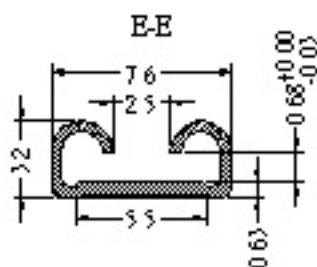

NOTE:

1. 每盤3K
2. 材料彎曲10°/1000mm(MAX)
3. 材料扭曲90°/1000mm(MAX)
4. 毛邊不超過0.025mm
5. 0.7厚插pin插拔力0.8kg~1.4kg

 C & J Professional

NORMAL DIMENSION TOLERANCE

X ±0.30 X ±2  
XX ±0.20  
XXX ±0.10

UNITS

mm

SCALE

1:1

MATERIAL

HEAT TREAT

QUANTITY

THIRD ANGLE PROJECTION

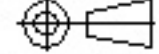

SHEET 1 OF 1

TITLE

DWG. NO.

DRAWN

CHECKED

APPROVED

Terminal

T250PF0TGF

Ma 2025.06.08

SIZE

A4

REV

A